

LED-LENOX

brass | 280lm | CRI>90

Product code: 65232S4



A modern furniture light fixture

LIMENTE LED-LENOX is a beautiful, traditional light fixture with a modern design. The light is wide-spread and pleasant, which makes LED-LENOX an excellent choice for a kitchen workspace, in showcases and on shelves. LED-LENOX is a modern, timeless choice. LIMENTE LED-LENOX can be installed either recessed or surface-mounted. The high-quality, metallic fixture is available in matte white, matte black, stainless steel or brass color

All LIMENTE LED-LENOX fixtures use a new technique, which makes the light provided even and excellent in color temperature. This generates optimal light and is easy and pleasant on the eyes. Due to their amazing luminosity, the fixtures can be placed up to 60-80cm apart! When the fixtures are placed on both sides of the cooker hood, you are able to receive excellent lighting to your cooktop.

Dimming and lighting control

Appropriate lighting for any occasion is made easy with our dimming and lighting control system. You can easily change the lighting and ambience in your home from efficient and bright to dim and cosy by dimming your LIMENTE LED-LENO 51 with our wireless system. You can use the same switch to adjust all the LIMENTE lights in the room, including various ceiling, panel and profile lights. The light adjusts smoothly at the same time while creating ambience for working, entertaining or any mood in between.

[Learn more from our website](#)

Easy installation

LIMENTE LED-LENOX is quick and easy to install. You can either install the fixture recessed or surface-mounted.

[Learn more from our website](#)

THE FOLLOWING ITEMS ARE INCLUDED

- 4 x spotlight
- 3m johdot with male TOP connector
- mounting rings
- screws
- driver
- plastic free packaging

LENOX 4X4W BRASS SPOTLIGHT

OVERVIEW

PRODUCT CODE	65232S4
GTIN-CODE	6438400004443
ELECTRICAL NUMBER	4139898
ETIM GENERAL NAME	Furniture luminaire
ETIM CLASS	Downlight/spot/floodlight EC001744
ETIM GROUP	41 Domestic light fittings
COLOUR	Gold / Brass
LAMP TYPE	LED

SPECIFICATIONS

PRODUCT DIMENSIONS	64.0 x 64.0 x 15.5
MOUNTING METHOD	Surface mounted/recessed mounted
COLOUR TEMPERATURE	4000 K
COLOUR RENDERING INDEX CRI	> 90
RATED LIFE TIME	35.000h (L80B10)
ENERGY EFFICIENCY CLASS	
LUMINOUS FLUX	4 x 280 lm
EFFICIENCY	70 lm/W
VOLTAGE	24 V DC
INGRESS PROTECTION CODE	IP44/IP20
NUMBER OF LEDS/M	
INPUT POWER	4 x 4 W
NUMBER OF SWITCHING CYCLES	> 50 000
AMBIENT TEMPERATURE RANGE	-20°C~50°C
INPUT POWER CONNECTOR	
WARRANTY PERIOD (MONTHS)	24
ADDITIONAL COVER (MONTHS)	36
INSTALLATION AND OPERATING MANUAL	https://www.limente.fi/Images/productpics/instructions/limente_led-lenox.pdf

LENOX 4X4W BRASS SPOTLIGHT

RECOMMENDED ACCESSORIES

PRODUCT CODE	PRODUCT
640451	SMART 451, WIRELESS LIGHTING CONTROL KIT, 24 V
640420	SMART 420, WIRELESS LIGHT CONTROL
640421	SMART 421, WIRELESS LIGHT CONTROL
640422	SMART 422, WIRELESS LIGHT CONTROL
640424	SMART 422, WIRELESS LIGHT CONTROL
640350	SMART 350 SET, WIRELESS LIGHT CONTROL, REMOTE CONTROL
640351	SMART 351, WIRELESS LIGHT CONTROL
640352	SMART 352, WIRELESS LIGHT CONTROL
640425	SMART 425, WIRELESS LIGHT CONTROL

LENOX 4X4W BRASS SPOTLIGHT

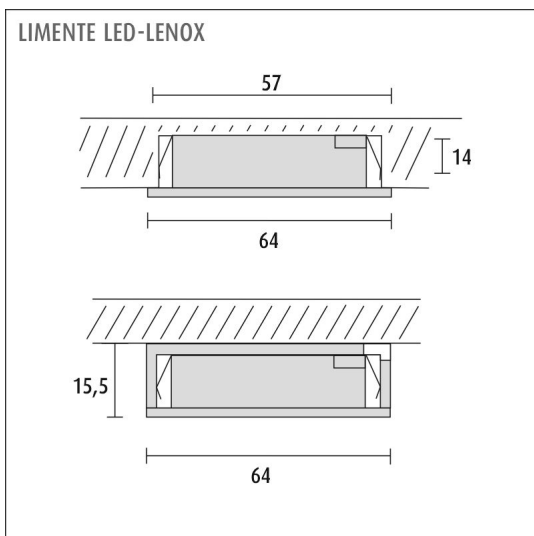
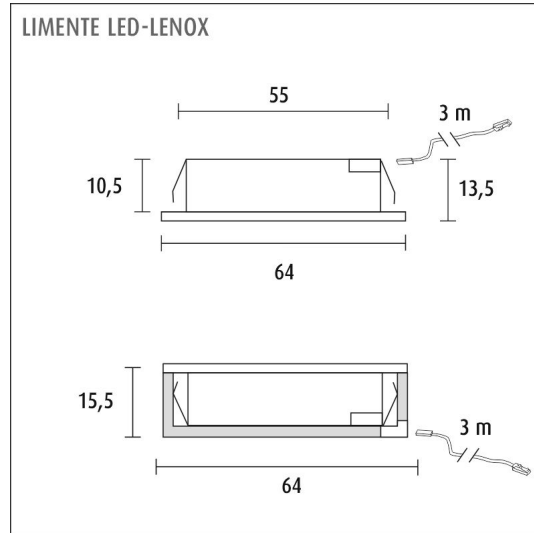
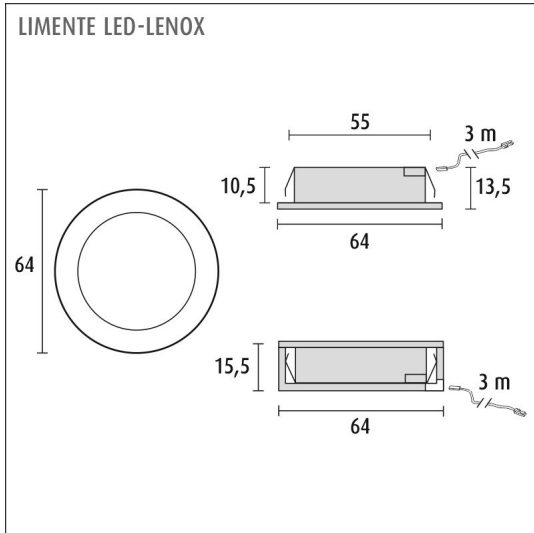

LENOX 4X4W BRASS SPOTLIGHT

