

SMART 512

ON/OFF IR-switch | 24 V

Product code: 640512S4



Automatic door switch and motion-responsive control- easy adjustment of lights

Automated lighting control is at its best when, the lights are on, when they are needed and where they are needed, without the user noticing. Unnecessary lights on and electricity consumption are reduced while safety is increased. The LIMENTE SENSOR series is designed to automate lighting control in all areas of home. In addition to the door switch, the LIMENTE SMART SENSOR 512 also acts as a switch that responds to hand movement below the sensor.

The SMART 512 door switch is installed behind either a sliding or turning door (on a distance of 0-10mm). In Door Switch mode, the system turns on the closet lights or even the breakfast cabinet lights when the door is opened and the light is needed. The lights stay on as long as the closet door is open. Automatic lighting control makes home lighting a new kind of comfort and safety product and at the same time it is also an ecological way to use lights.

[Learn more from our website](#)

Adjusting the lights

LIMENTE SMART 512 acts as an automatic door ON / OFF switch or, in hand-wave switch mode, also as a dimmer control. When you wave your hand in front of the sensor, the lights go out or on. When the hand is held in front of the sensor for more than one second, the system will dim / brighten the lights. When used as a door switch, the switch turns on the lights when the door is opened and turns them off when the door is closed.

Installation

The LIMENTE SMART SENSOR series electronics unit and sensor are simple and quick to install and do not require separate electrical installations. First, select the desired operating mode on the electronics unit so that the sensors work the way you want them to.

[Learn more from our website](#)

THE FOLLOWING ITEMS ARE INCLUDED

- 4 x sensor with 2m cable and quick connector
- manifold with quick connector

SMART 512 4XIR-SWITCH SET

OVERVIEW

PRODUCT CODE	640512S4
GTIN-CODE	6438400005341
ELECTRICAL NUMBER	2600893
ETIM GENERAL NAME	Motion detector
ETIM CLASS	Movement sensor / presence detector complete EC000133
ETIM GROUP	26 Timer switches, thermostats and lighting controls
COLOUR	Alulook
LAMP TYPE	

SPECIFICATIONS

PRODUCT DIMENSIONS	70.0 x 70.0 x 16.0
MOUNTING METHOD	Surface mounted/recessed mounted
COLOUR TEMPERATURE	
COLOUR RENDERING INDEX CRI	
RATED LIFE TIME	
ENERGY EFFICIENCY CLASS	
LUMINOUS FLUX	
EFFICIENCY	
VOLTAGE	24 V DC
INGRESS PROTECTION CODE	IP20
NUMBER OF LEDS/M	
INPUT POWER	
NUMBER OF SWITCHING CYCLES	
AMBIENT TEMPERATURE RANGE	-20°C -+50°C
INPUT POWER CONNECTOR	
WARRANTY PERIOD (MONTHS)	24
ADDITIONAL COVER (MONTHS)	
INSTALLATION AND OPERATING MANUAL	https://www.limente.fi/Images/productpics/instructions/limente_smart500.pdf

SMART 512 4XIR-SWITCH SET

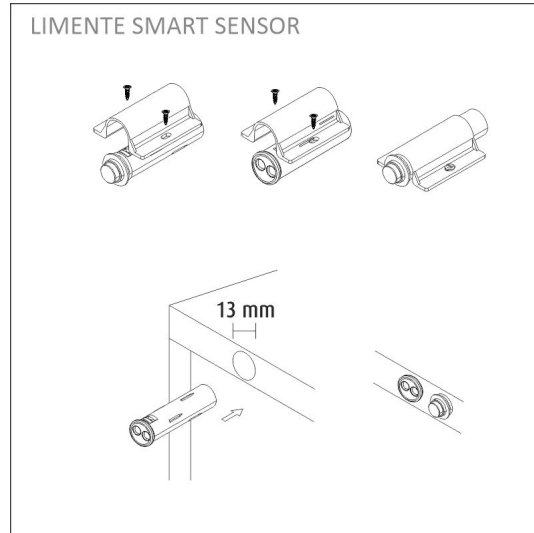
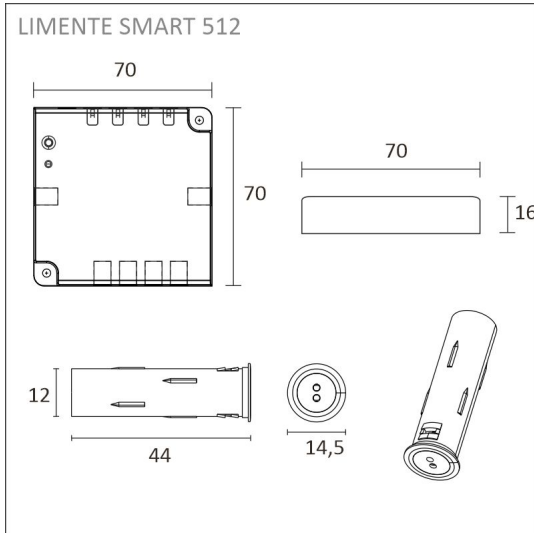

SMART 512 4XIR-SWITCH SET

Limente Smart 512

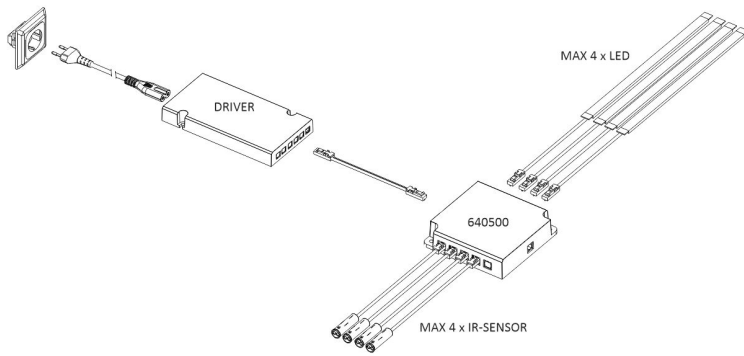

LIMENTE
HELSINKI

Limente Smart on/off/dim + Profil LUX

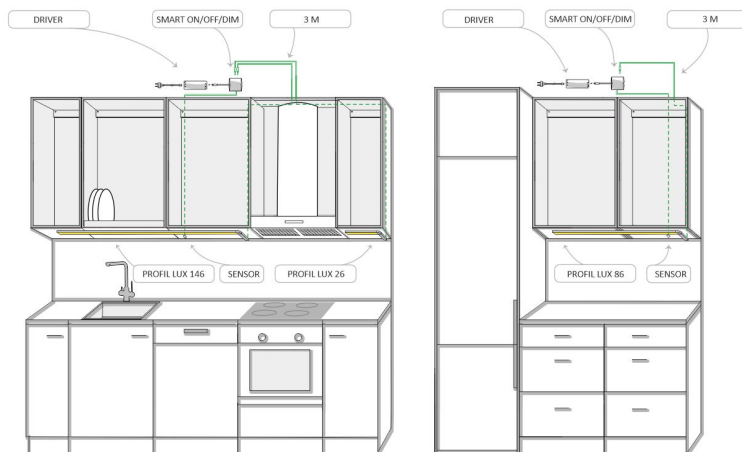

LIMENTE
HELSINKI